



浙江春生电子有限公司
ZHEJIANG CHUNSHENG ELECTRONICS CO.,LTD.

地 址：浙江省乐清市虹桥镇东工业区幸福东路1288-5号
 电 话：0577-57578000 62352608 62367708 62367706
 传 真：0577-62351573 62351572
 网 址：<http://www.chunsheng.com>
 邮 箱：saler@chunsheng.com
 邮 编：325608

Add: Chunsheng Electronics Building No.1288-5,Xingfu
 East Road,East Industrial Zone, Hongqiao Town,
 Yueqing City, Zhejiang Province, China
 Tel: +86-577-57578000 62352608 62367708 62367706
 Fax: +86-577-62351573 62351572
 Web: <http://www.chunsheng.com>
 E-mail: saler@chunsheng.com
 P.C: 325608



2016.09



春生电子
CHUNSHENG ELECTRONICS



» **Product catalog**

PROFESSIONAL AUDIO JACK SERIES



公司简介

浙江春生电子有限公司始创于1984年，1997年注册“”商标，是一家集开发设计、制造、营销为一体的专业电子接插件、电子元器件等电子产品制造企业。产品广泛应用于各类通讯设备、专业音响、家用电器、电脑、数码移动和消费电子产品等领域。

公司秉持专业化生产的理念，不断创新研发，致力于专业制造，恪守质量政策方针，为客户提供互连解决方案。产品远销美国、欧洲、东南亚、澳大利亚、日本、韩国等国家和地区。

公司现有多个生产基地，拥有一批高素质的专业技术人才和管理人才，为众多国际知名品牌提供设计开发方案。通过了ISO9001质量体系认证、ISO/TS16949质量体系认证、ISO14001环境体系认证。

优良的品质和客户满意的服务源于品牌经营的理念。浙江春生电子有限公司本着“高质、求实、创新、奉献”的企业精神，为客户提供满意的产品和服务。

BRIEF INTRODUCTION

Zhejiang Chunsheng Electronics Co., Ltd. was founded in 1984, registered trademark “” in 1997, which is a professional electronic connector and other electronic products manufacturer that incorporates development, design, manufacture and marketing. Our products are widely applied to such fields as communications equipment, professional audio, home appliances, computers and consumer electronics.

Chunsheng adheres to the concept of specialized production, maintains innovative research and develop, commits to professional manufacture as well as abides by the quality policy, provides interconnect solution to our customers. Our products are exported to the United States, Europe, Southeast Asia, Australia, Japan, South Korea and other countries and regions.

Chunsheng owns several production plants as well as has a number of high-quality professional technical personnel and management personnel, providing design-in solution to many international famous brands. Chunsheng also passed ISO9001:2008, ISO/TS16949-2009 and ISO14001:2004 certification.

Excellent quality and customer satisfying service comes from the concept of brand cherishing. Chunsheng always focus on providing customer with satisfactory products and services with the spirit of “High Quality, Best Service, Sincerity, Innovation and Dedication” .

以优质产品与服务
实现组织的持续改进
促进发展
争创名优名牌企业!

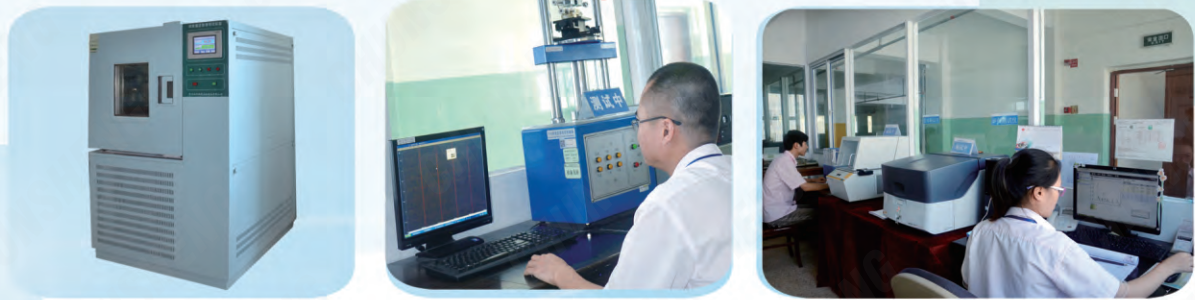

精确设计 精心制造 精诚服务





春生电子

CHUNSHENG
ELECTRONICS



公司宗旨： 以人为本 求实创新
诚信经营 产业兴国

经营理念： 客户第一 品质至上 诚信合作

COMPANY PURPOSE :

BE HUMAN ORIENTED. FACTUALISM AND INNOVATION
HONEST OPERATION. INDUSTRIAL FOR COUNTRY-DEVELOPING

MANAGEMENT CONCEPT :

CUSTOMER FIRST QUALITY FIRST GOOD FAITH COOPERATION

★★★ 以优质产品与服务实现组织的持续改进，促进发展，争创名优名牌企业！

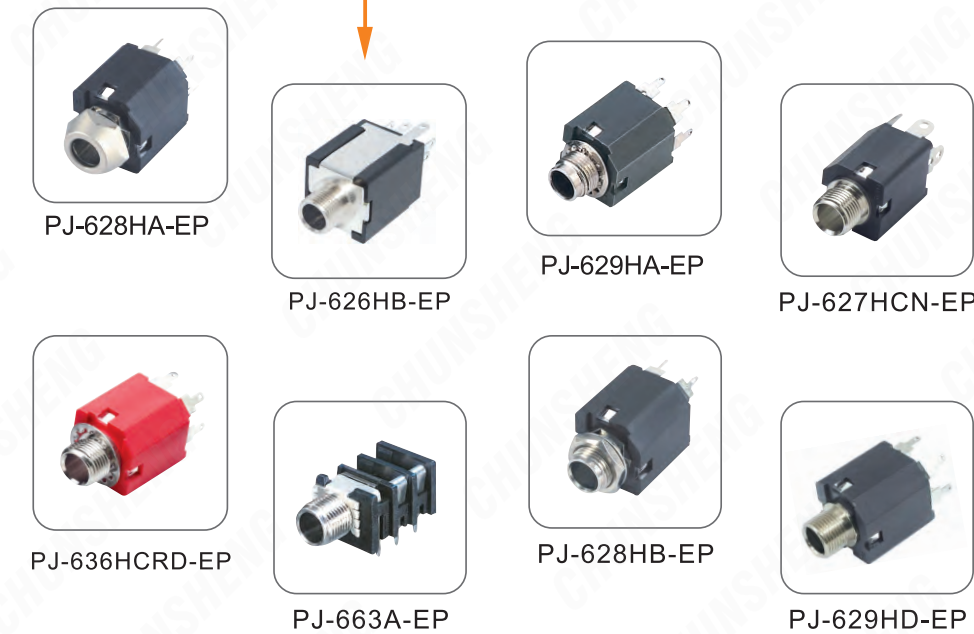



CT3-03HM-EP



CT3-03HMA-EP



CT3-03HMD-EP



CT3-05HM-EP



CT3-05HM-01-EP



CT3-05HM-02-EP



CT3-05HM-03-EP



HP-01-EP



HP-11M3-EP



HP-06-EP



HP-35-EP



HP-07M3-EP



HP-37T-EP



HP-10M3-EP



HP-32LM3-EP



CT3-04FP-EP



CT3-04HFP-EP



CT3-04FAP-EP



CT3-04HFAP-EP



CT3-04FBP-EP



CT3-04HFBP-EP



CT3-04HFP-A-EP



CT3-04FP-A-EP



CT3-12FBP-EP



CT3-12HFAP-EP



CT3-12HFBP-EP



CT3-12HFP-EP



CT3-12FAP-EP



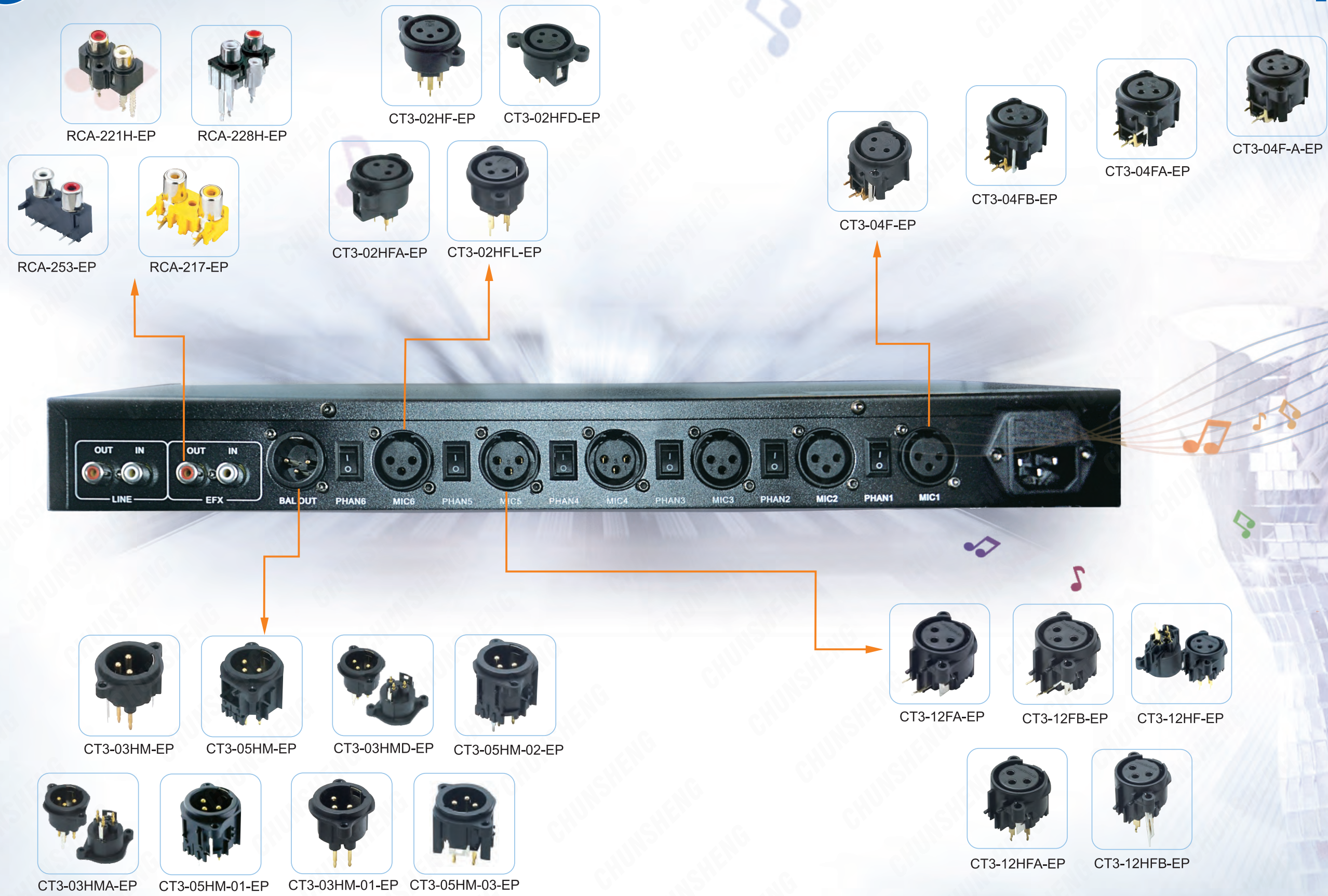



RCA-228HA-EP



RCA-235HA-EP



RCA-221HLA-EP



RCA-221HA-EP



CT3-03HM-EP



CT3-05HM-EP



CT/PJ-01HP-EP



CT/PJ-02P-EP



CT/PJ-03HP-EP



CT3-03HMA-EP



CT3-05HM-01-EP



CT/PJ-01HP-10-EP



CT/PJ-02P-10-EP



CT/PJ-03HP-10-EP



CT3-03HMD-EP



CT3-05HM-02-EP



CT/PJ-01HP-07-EP



CT/PJ-02P-07-EP



CT/PJ-03HP-07-EP



CT3-03HM-01-EP



CT3-05HM-03-EP



CT/PJ-01HP-06-EP



CT/PJ-02P-06-EP



CT/PJ-03HP-06-EP



HP-01-EP



HP-11M3-EP



HP-32LM3-EP



HP-10M3-EP



HP-07M3-EP



HP-06-EP



HP-35-EP



HP-37T-EP

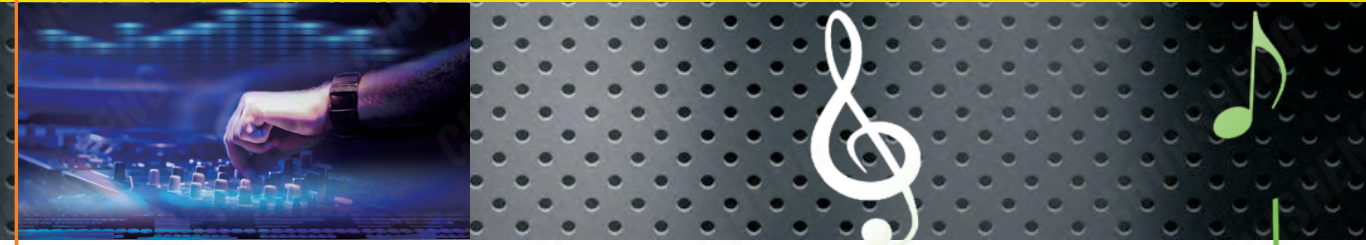

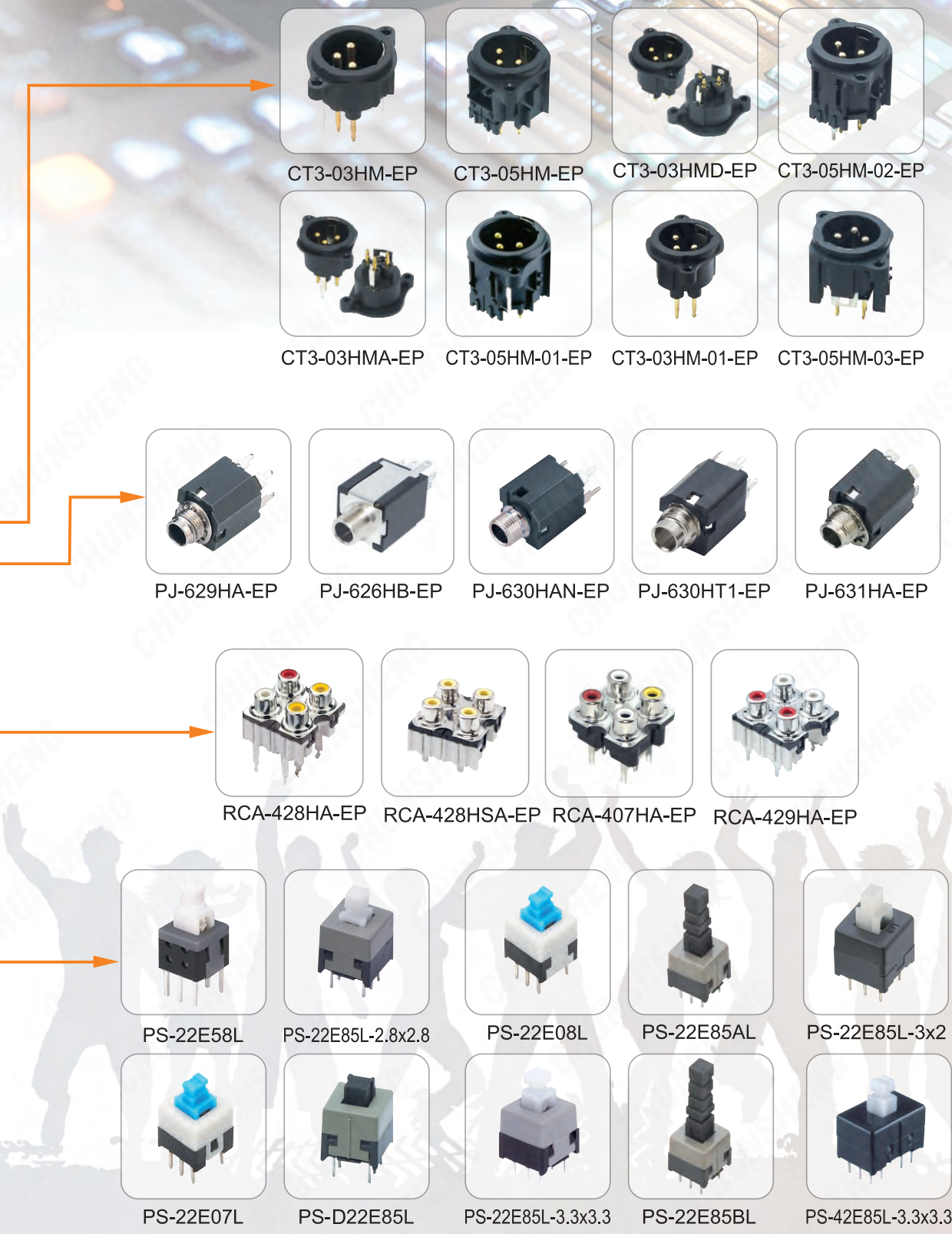

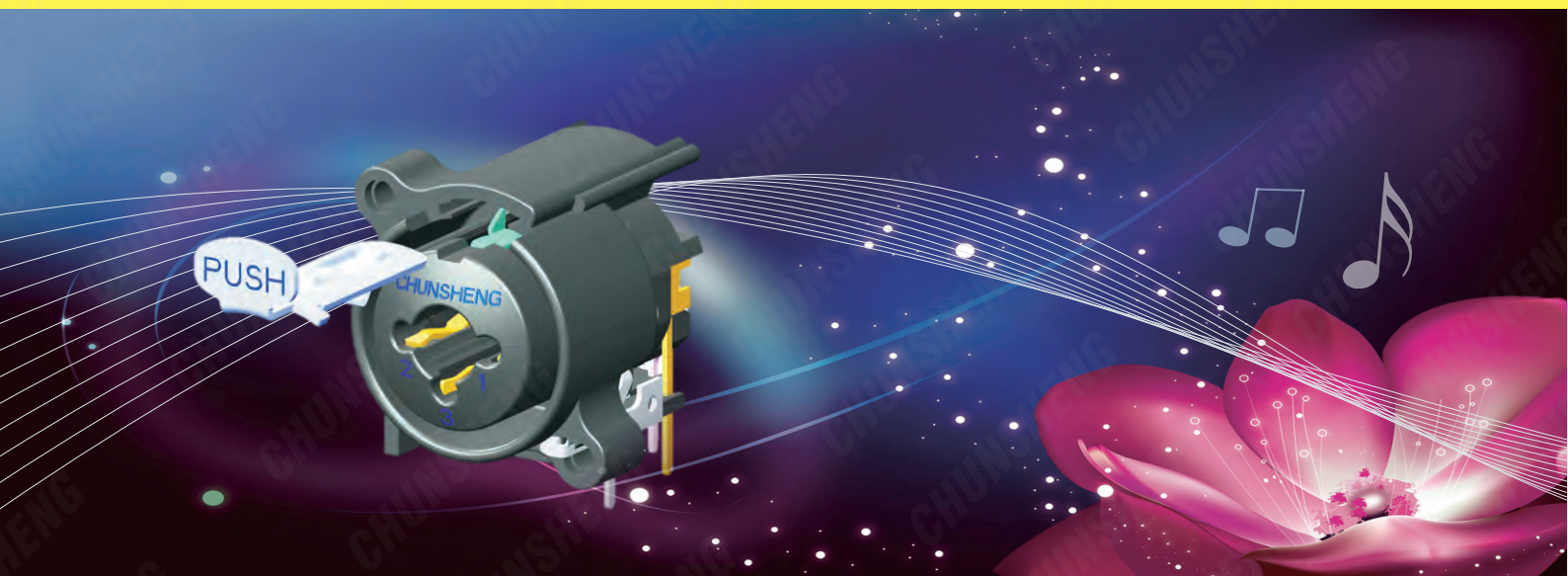

◆ 技术参数 [Specification]

ELECTRICAL 电气性能:

RATED CURRENT: 7.5A MAX.
额定电流: 7.5A MAX.
RATED VOLTAGE: 50 V AC(RMS)/DC.
额定电压: 50 V AC(RMS)/DC.
CONTACT RESISTANCE: XLR: 20 MILLIOHMS MAX.
JACK: 30 MILLIOHMS MAX.
接触电阻: XLR: 20 MILLIOHMS MAX.
JACK: 30 MILLIOHMS MAX.
INSULATION RESISTANCE: 500 MEGAOHMS MIN.
绝缘电阻: 500 MEGAOHMS MIN.
DIELECTRIC WITHSTANDING VOLTAGE: 1500 VAC MIN.
耐电压: 1500 VAC MIN.

MECHANICAL 机械性能:

INSERTION FORCE: XLR: 5-50 N.
JACK: 5-45 N.
插入力: XLR: 5-50 N.
JACK: 5-45 N.
WITHDRAWAL FORCE: XLR: 5-50 N.
JACK: 5-45 N.
拔出力: XLR: 5-50 N.
JACK: 5-45 N.
DURRABILITY: 5000 CYCLES MIN.
耐久性: 5000 CYCLES MIN.
ENVIRONMENTAL 环境性能:
TEMPERATURE:
温度范围: -25°C TO +65°C.
FLAME CLASS 阻燃等级
OPTIONAL(可选): UL94HB, UL94V-0

CT/PJ-12H-EP

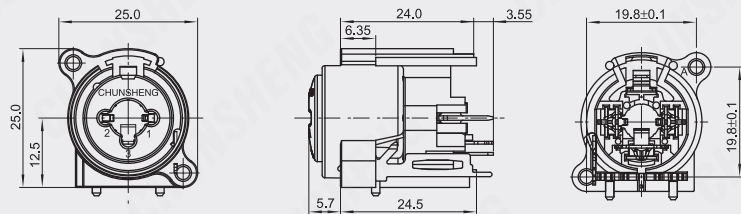

CT/PJ-13P-EP

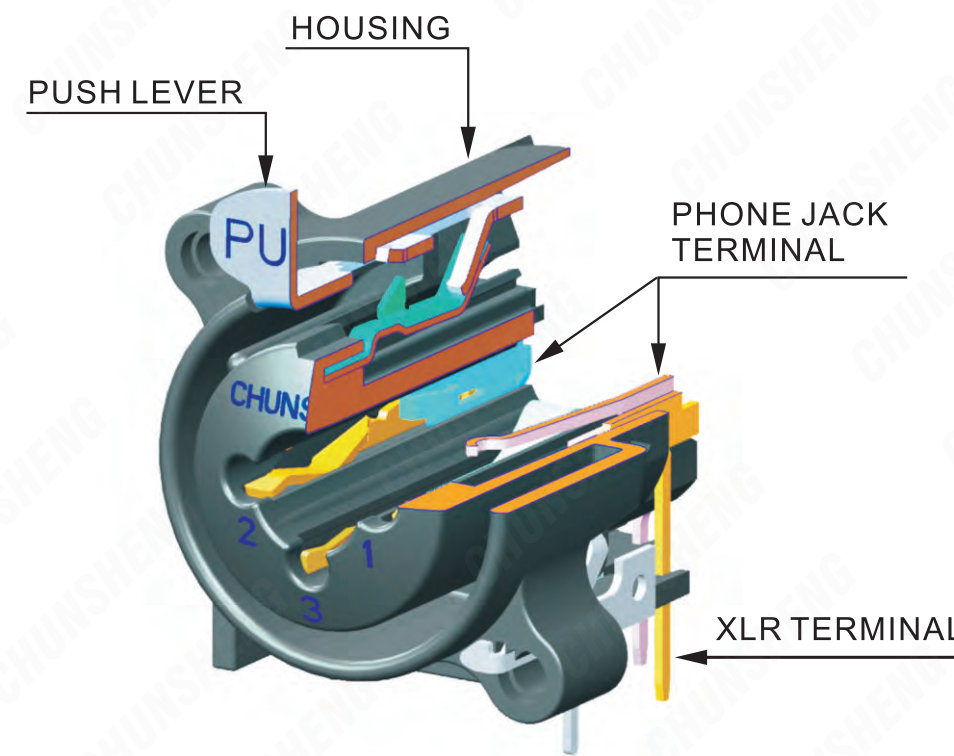
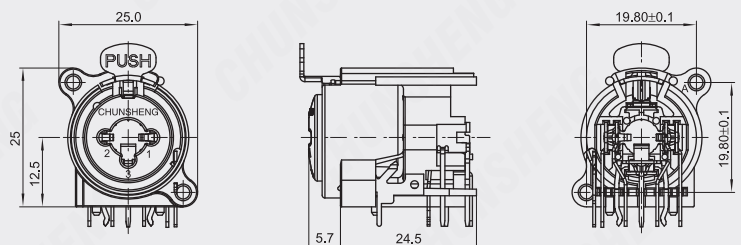

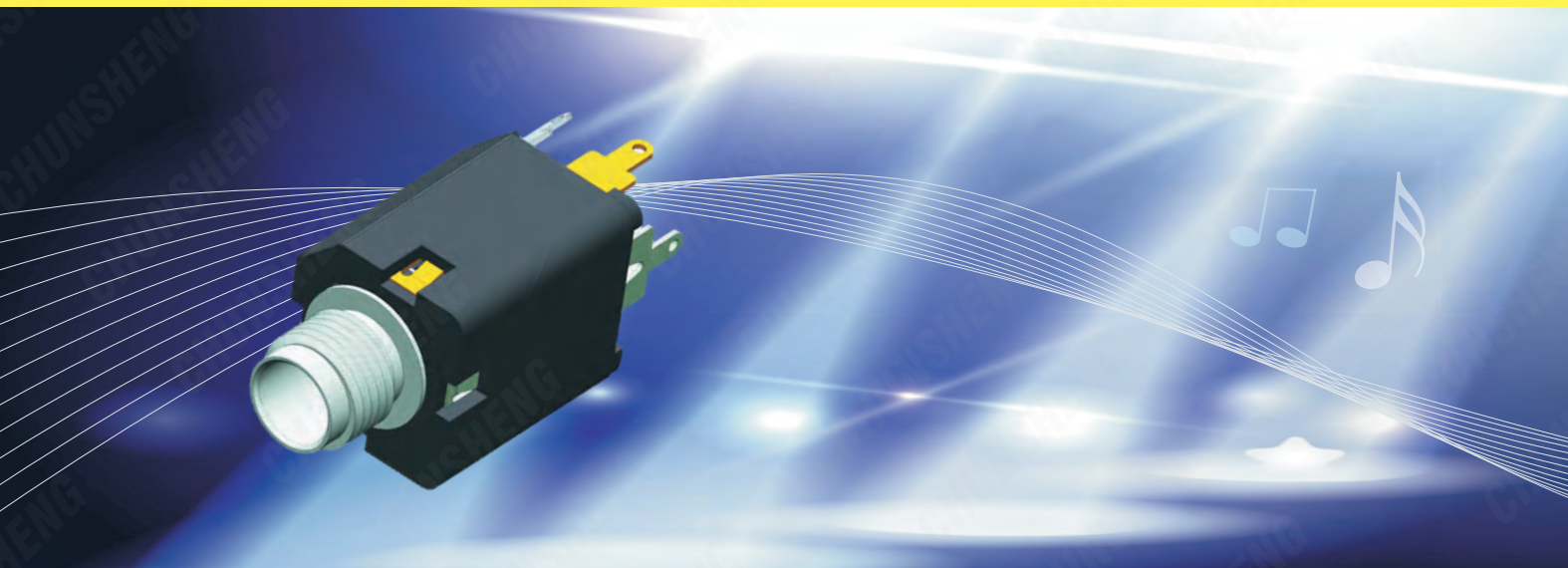

◆ 技术参数 [Specification]

ELECTRICAL 电气性能:

RATED CURRENT: 0.5 A MAX.
额定电流: 0.5 A MAX.
RATED VOLTAGE: 50 V AC(RMS)/DC.
额定电压: 50 V AC(RMS)/DC.
CONTACT RESISTANCE: 30 MILLIOHMS MAX.
接触电阻: 30 MILLIOHMS MAX.
INSULATION RESISTANCE: 100 MEGAOHMS MIN.
绝缘电阻: 100 MEGAOHMS MIN.
DIELECTRIC WITHSTANDING VOLTAGE: 500 VAC MIN.
耐电压: 500 VAC MIN.

MECHANICAL 机械性能:

INSERTION FORCE: 5-40 N.
插入力: 5-40 N.
WITHDRAWAL FORCE: 5-40 N.
拔出力: 5-40 N.
DURRABILITY: 5000 CYCLES MIN.
耐久性: 5000 CYCLES MIN.
ENVIRONMENTAL 环境性能:
TEMPERATURE::
温度范围: -25°C TO +70°C.
FLAME CLASS 阻燃等级
OPTIONAL(可选): UL94HB,UL94V-0

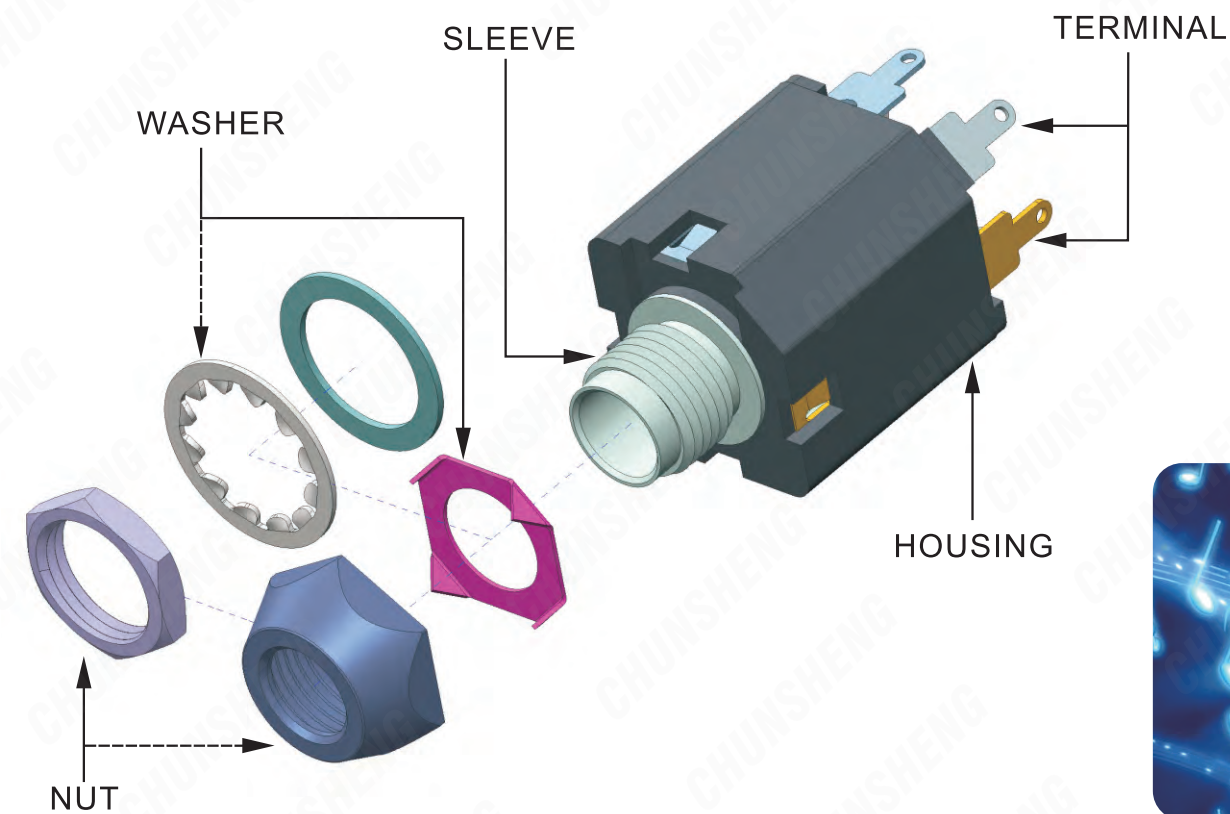
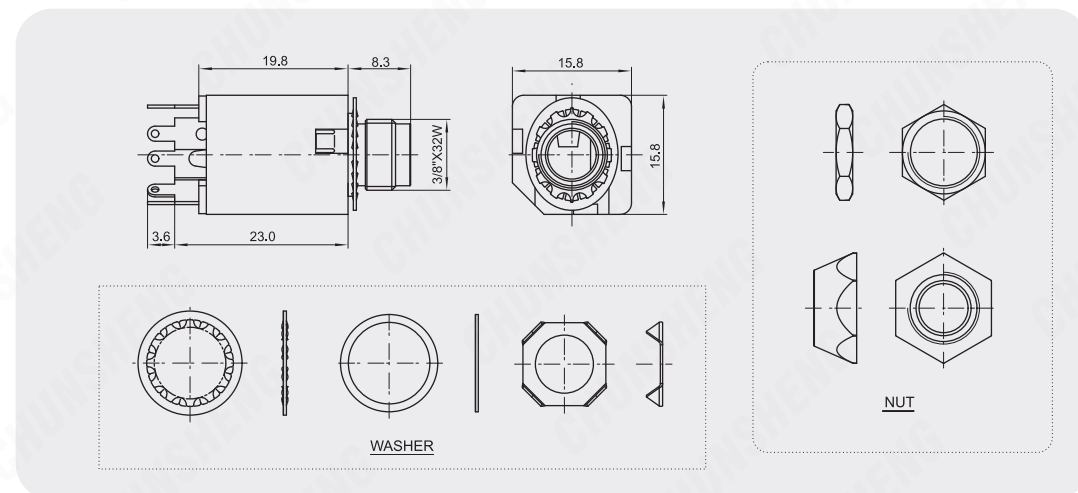



◆ 技术参数 [Specification]

ELECTRICAL 电气性能:

RATED CURRENT: 6 A MAX.
额定电流: 6 A MAX.
RATED VOLTAGE: 50 V AC(RMS)/DC.
额定电压: 50 V AC(RMS)/DC.
CONTACT RESISTANCE: 30 MILLIOHMS MAX.
接触电阻: 30 MILLIOHMS MAX.
INSULATION RESISTANCE: 100 MEGAOHMS MIN.
绝缘电阻: 100 MEGAOHMS MIN.
DIELECTRIC WITHSTANDING VOLTAGE: 1500 VAC MIN.
耐电压: 1500 VAC MIN.

MECHANICAL 机械性能:

INSERTION FORCE: 10-50 N.
插入力: 10-50 N.
WITHDRAWAL FORCE: 10-50 N.
拔出力: 10-50 N.
DURABILITY: 5000 CYCLES MIN.
耐久性: 5000 CYCLES MIN.
ENVIRONMENTAL 环境性能:
TEMPERATURE: -30°C TO +80°C.
温度范围: -30°C TO +80°C.
FLAME CLASS 阻燃等级
OPTIONAL(可选): UL94HB, UL94V-0

CT3-04FA-EP

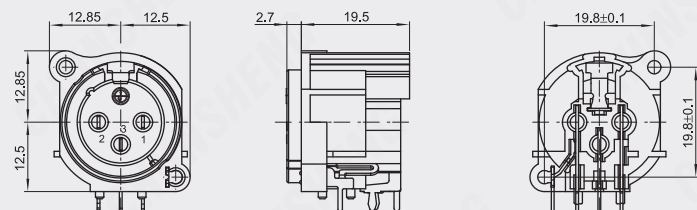

CT3-04HFAP-EP

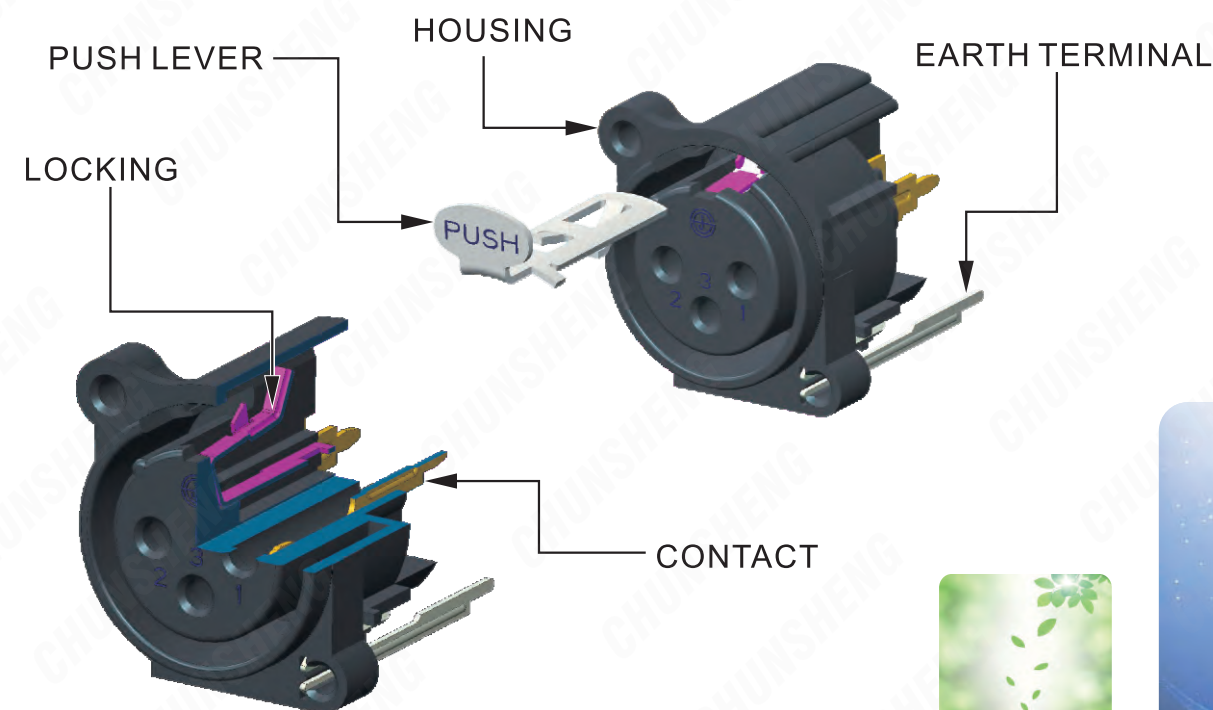
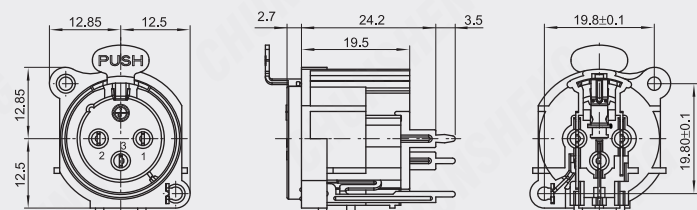

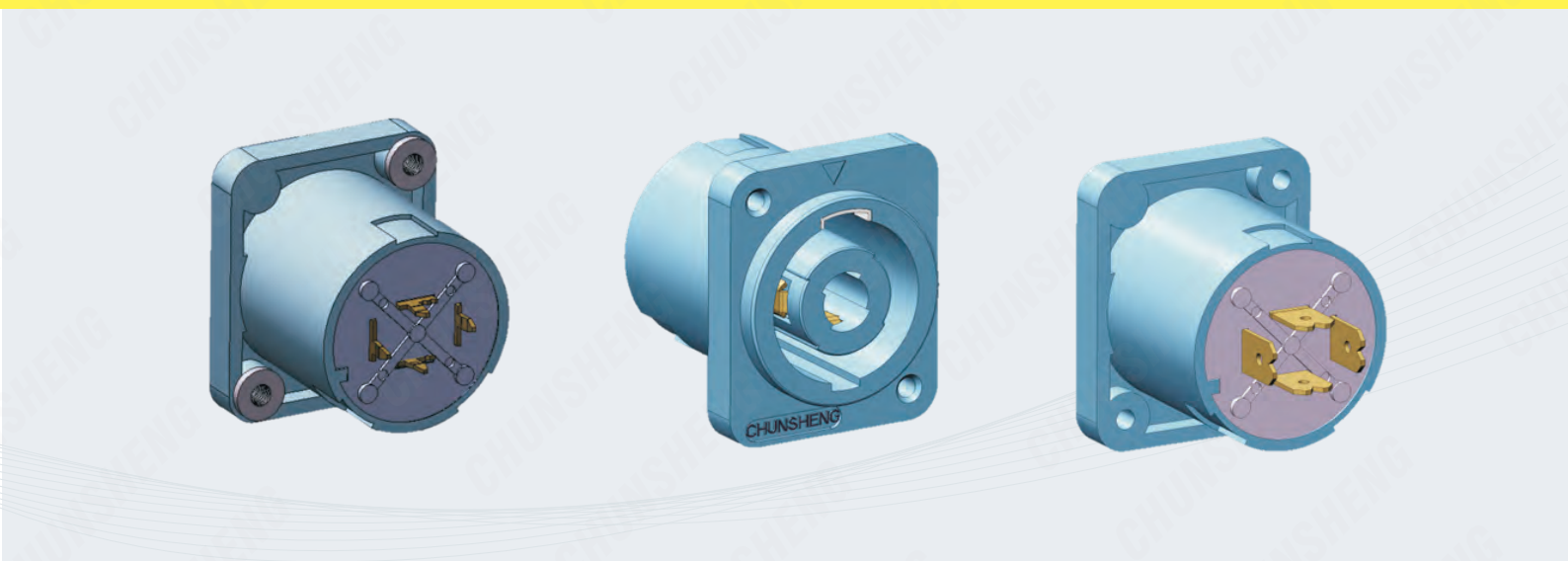

◆ 技术参数 [Specification]

ELECTRICAL 电气性能:

RATED CURRENT PER CONTACT, 40 A rms CONTINUOUS: 30 A.
各触点额定电流, 连续40 A rms: 30 A.
RATED VOLTAGE: 50 V AC(RMS)/DC.
额定电压: 50 V AC(RMS)/DC.
CONTACT RESISTANCE: 10 MILLIOHMS MAX.
接触电阻: 10 MILLIOHMS MAX.
INSULATION RESISTANCE: 100 MEGAOHMS MIN.
绝缘电阻: 100 MEGAOHMS MIN.
DIELECTRIC WITHSTANDING VOLTAGE: 1500 VAC MIN.
耐电压: 1500 VAC MIN.

MECHANICAL 机械性能:

INSERTION FORCE: 20 N MAX.
插入力: 20 N MAX.
WITHDRAWAL FORCE: 10 N MIN.
拔出力: 10 N MIN.
DURRABILITY: 5000 CYCLES MIN.
耐久性: 5000 CYCLES MIN.
ENVIRONMENTAL 环境性能:
TEMPERATURE::
温度范围: -30°C TO +80°C.
FLAME CLASS 阻燃等级
OPTIONAL(可选): UL94HB, UL94V-0

